

# Installation manual for: 2116G43C/RC

Dimensions : D43" H5.11" L24  
Collection : CUVETTE  
Bulb Type : G9 bulb, bulb not include  
Total Weight : 57.2 LBS



Thank you for choosing our exquisite products. We are providing the finest quality crystal products for our customers. Our master designers and craftsmen intend to give a professional insight on lighting design and product quality. Prompt and efficient services are our priority. We enclosed detailed instructions on how to install your light fixture properly. Please read all instructions carefully and thoroughly. If you have any questions, our professional customer service team is committed to assisting you, please call our toll free HOTLINE AT:

**1-888-388-3390**



**SAFETY**

Warning: MAKE SURE THE ELECTRICITY TO THE WIRES YOU ARE WORKING ON IS SHUT OFF. BY EITHER REMOVING THE FUSE OR TURNING OFF THE CIRCUIT BREAKER.

**CAUTION**

- Before assembling the lighting fixture, please read all instructions carefully.
- All frame & crystal components are fragile, please handle with care.
- Required supply circuit : 110 - 130V/60Hz
- Labeled wires are "L" for live wire, "N" for neutral wire, "E" for GND.
- Never install fixture on damp ceiling, the room should be dry and well ventilated.
- All electrical components must be installed by a licensed electrician and in accordance with the National Electrical Code and the appropriate local electrical codes.

**Unpack the Package**

Please open the box carefully and check all the items are inside the box. If you have any installation, assembling and missing parts questions, please call our Customer Service department at 1-888-388-3390. Please have model number(at the front page), where you purchase from and any other relevant information ready, our customer service team will provide comprehensive and worry free service to our valued customers.

01

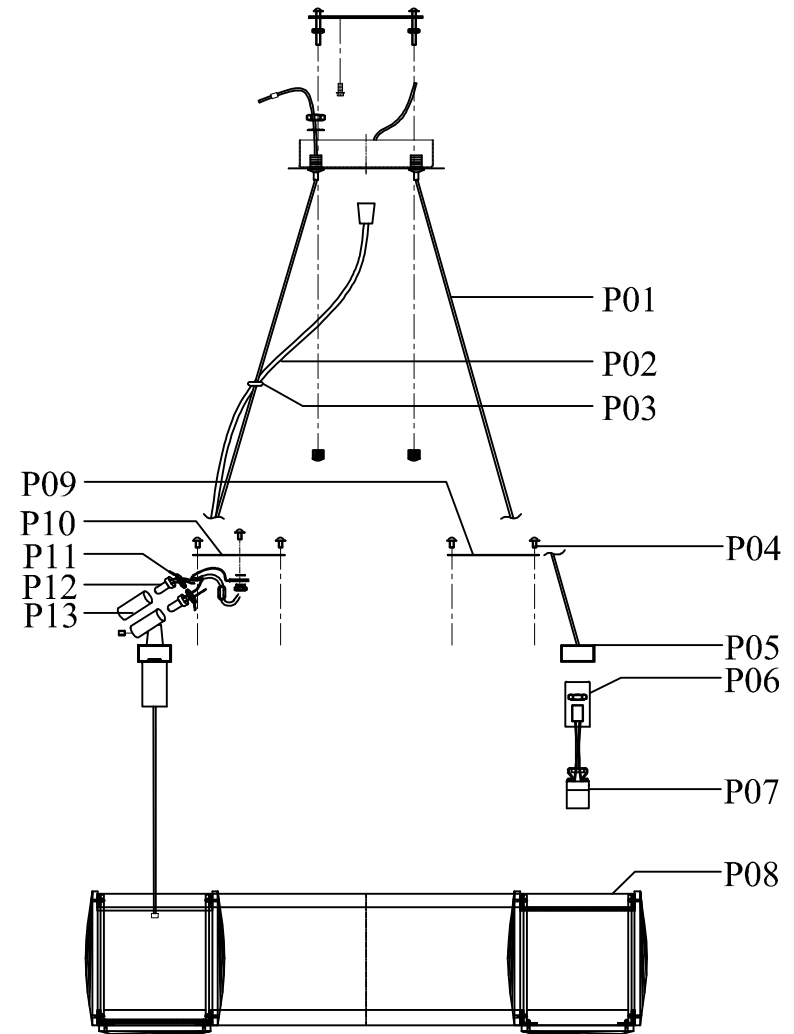
**Frame Parts List**

02

















2116G43 D43" H5.11" L24

# Step 1





Please use the parts list to ensure you are not missing any parts.

2116G43

## PARTS LIST

part	picture	Description	Parts Number	Qty	Check list
ZA		Electrical box(not include)		1	
ZB		GND	CP302116R71RC	1	
ZC		Junction Caps		3	
ZD		Mounting bracket(L6.7"*W6.7")		1	
ZE		Canopy(ø7.1"H1",Chrome)		1	
ZF		M4 Knurled nut		4	
ZG		Mounting bracket screw		2	
ZH		Round stainless steel plate(ø5.5"×0.03")		1	
P01		Steel cope L118"		4	
P02		Clear Round Electrical Wire(L141.7",18#)		1	
P03		Plastic washer		2	
P04		M4 Flange bolt(L0.23")		9	
P05		Pipe ring body (Ø38.4"H0.6")		1	
P06		Socket cover(ø0.9"H1.7",Chrome,Iron)		24	
P07		G9 Socket		24	
P08		Crystal frame body with crystal (Ø43"H5.11")		1	

2116G43 D43" H5.11" L24

part	picture	Description	Parts Number	Qty	Check list
P09		Two holes steel bracket A		3	
P10		Two holes steel bracket B		1	
P11		Cable tie		6	
P12		Junction caps		6	
P13		Heat shrink tubing		6	

2116G43 D43" H5.11" L24

part	picture	Description	Parts Number	Qty	Check list

2116G43 D43" H5.11" L24

part	picture	Description	Parts Number	Qty	Check list

## Canopy Installation Instruction

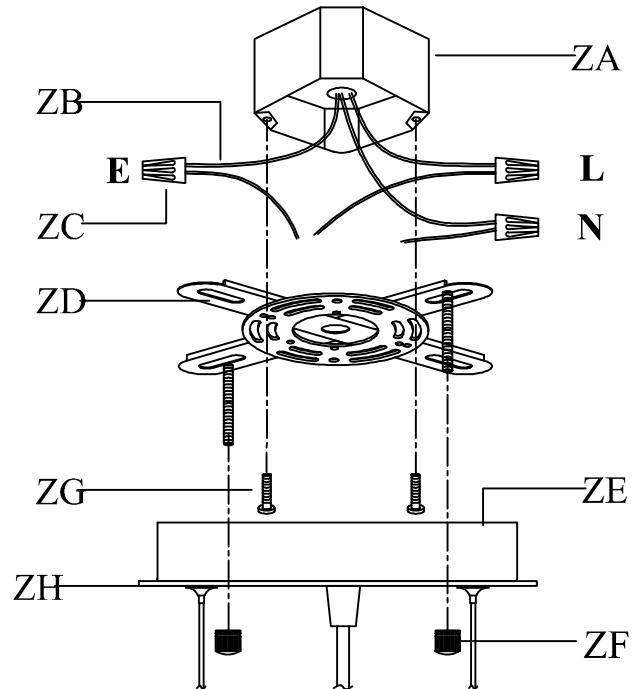

"L" = Hot wire

"N" = Neutral wire

"E" = GND

**IMPORTANT:** Test sockets with bulb before dressing the fixture.

- 1 .Attach the Mounting bracket(ZD) to the electrical box(ZA).
- 2 .Pull wires up through the Junction Caps(ZC).
- 3 .Attach the Canopy(ZE) to the ceiling panel.
- 4 .Make the electrical connections as detailed in the drawing above.

## Frame Assembly Diagram

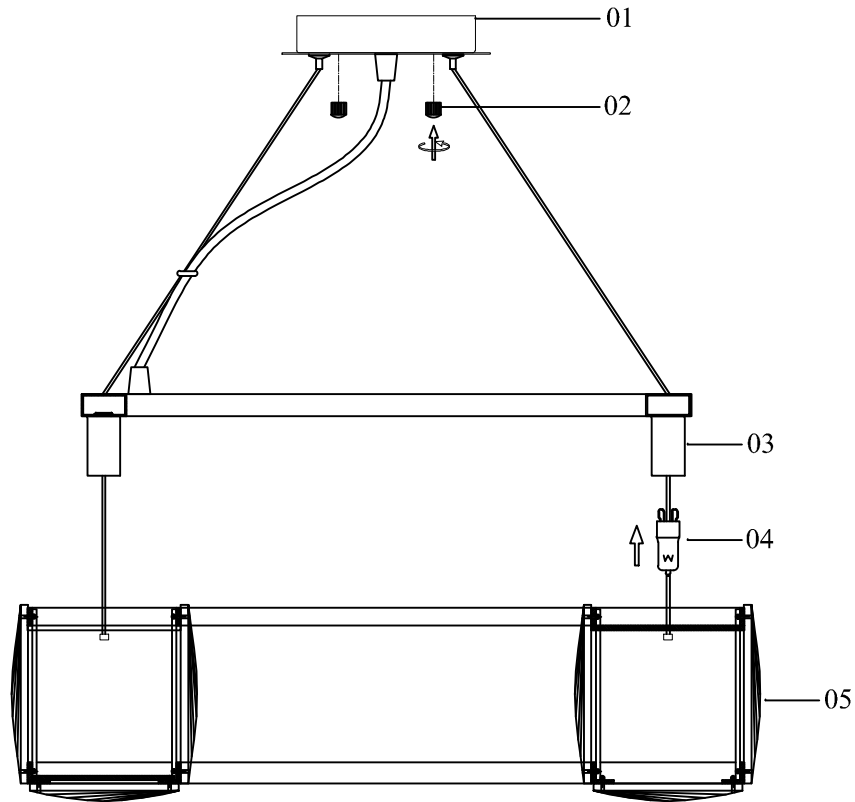

## Step 3 Frame Assembly Instructions

Installation:

Please read all instructions carefully.

Before you proceed to install, make sure that the power supply is turned off and remains off until installation is complete.

Please note that each part has been assigned a number.

Please proceed in a numerical order.

1. Install G9 Bulb(04) to G9 Socket(03). (bulb not include)
2. Put the Light body ring on Crystal frame body with crystal(05).
3. Use Knurled nut(02) to fasten Canopy(01) together with Mounting bracket of Ceiling panel.

The end!

# Congratulations !

You are now done installing your Elegant Lighting fixture.  
Sit back and admire each crystal as it will become the statement piece for your room/house.

If you require any additional assistance,  
please contact us at 1-888-388-3390.

Thank you.

## Cleaning and Maintenance of Chandelier Frame

The finish on our chandelier frames and fixture frames is protected by a durable coating of lacquer. To clean, use a clean soft, dry cloth. Do not use any metal polishes, cleaners, abrasives or any substance which could remove the protective finish.

Failure to follow these instructions automatically voids the guarantee.

## Cleaning and Maintenance of Crystals

Wet a soft cotton fabric in clean warm water and wipe gently, then polish with a dry soft cotton fabric.

## To Order Crystal Replacement Parts

Should you require replacement crystals or pins (the metal connectors attaching the crystals), contact the store where the product was purchased or contact us at the address shown on the reverse side. For ease of ordering, you may use the original crystal trimming instructions provided with this product and circle the items you wish to order, indicating the quantity by writing the number needed adjacent to the circle and faxing it to our customer service department at

215-423-8882. You will be contacted with prices prior to shipment.

All orders must be pre-paid.

## Elegant Lighting Warranty

The finish and frame of your new chandelier or fixture are warranted for a period of two (2) years from the date of purchase. Our company will, at its option, repair or replace any frame that has a defect in the materials or workmanship during the warranty period. All crystals are guaranteed for their original quality during the life of the chandelier. Breakage is not covered by this warranty.

To make a claim under this warranty, contact our customer service department at the address and phone number shown below. A written return authorization form will be sent to you with specific instructions.

### CUSTOMER SERVICE DEPARTMENT

500-550 E. Erie Avenue

Philadelphia, PA 19134

Tel : 215-423-8880

Fax : 215-423-8882

## Returns and Conditions of Warranty

Returns must be pre-authorized by contacting our customer service department at the address on the reverse side. Returns will only be accepted with a written return merchandise authorization and return shipping charges pre-paid. We reserve the right to inspect all returned merchandise to fully determine the nature of any defect. This guarantee shall not apply to any product that has been changed, altered or otherwise modified, nor shall it apply to any product that has been repaired or altered by anyone other than a pre-authorized facility. We will not be responsible for any breakage or damages incurred during transit, nor for crystal parts or metal frame part that have been subject to misuse, negligence, accident or inappropriate handling. Also, we will not be held responsible for damage incurred during improper installation or wiring by others, nor for damages resulting from a failure to follow the recommended maintenance or installation procedures. This guarantee is issued in lieu of any and all other guaranteed or warrantee, whether written or implied and any and all other obligations or liabilities. Further, we neither authorize nor permit any other person or firm to assume for us, any liability in connection with the sale of our products.